

**1N2970 thru
1N3015B
and
1N3993 thru
1N4000A**

FEATURES

- ZENER VOLTAGE 3.9 to 200V
- VOLTAGE TOLERANCES; $\pm 5\%$, $\pm 10\%$ and $\pm 20\%$ (See Note 1)
- MAXIMUM RELIABILITY FOR MILITARY ENVIRONMENTS (See † Below)

MAXIMUM RATINGS

Junction and Storage Temperatures: -65°C to $+175^{\circ}\text{C}$
DC Power Dissipation: 10 Watts
Power Derating: 80 mW/ $^{\circ}\text{C}$ above 50°C
Forward Voltage @ 2.0 A: 1.5 Volts

***ELECTRICAL CHARACTERISTICS @ 30°C Case Temperature**

JEDEC TYPE NO. (Note 1)	NOMINAL ZENER VOLTAGE $V_Z @ I_{ZT}$ Volts (Note 2)	ZENER TEST CURRENT I_{ZT} mA	MAX. DYNAMIC IMPEDANCE (Note 3)		MAX. DC ZENER CURRENT I_{ZM} @ 75°C Stud Temp. (Note 4) mA	TYPICAL TEMP. COEFF. α_{VZ} %/°C	MAX** LEAKAGE CURRENT I_R @ V_R μA Volts	POLARITY	
			$Z_{11} @ I_{ZT}$ OHMS	$Z_{2k} @ I_{Zk}$ OHMS					
†1N3993A	3.9	640	2.0	400	2380	-0.46	100	0.5	STD. POLARITY CATHODE TO STUD
†1N3994A	4.3	580	1.5	400	2130	-0.33	100	0.5	
†1N3995A	4.7	530	1.2	500	1940	-0.15	50	1.0	
†1N3996A	5.1	490	1.1	550	1780	± 0.10	10	1.0	
†1N3997A	5.6	445	1.0	600	1620	+0.30	10	1.0	
†1N3998A	6.2	405	1.1	750	1460	+0.49	10	2.0	
†1N3999A	6.8	370	1.2	500	1330	+0.40	10	2.0	
†1N4000A	7.5	335	1.3	250	1210	+0.45	10	3.0	
†1N2970B	6.8	370	1.2	500	1,320	.040	150	5.2	STD. POLARITY ANODE TO STUD
†1N2971B	7.5	335	1.3	250	1,180	.045	100	5.7	
†1N2972B	8.2	305	1.5	250	1,040	.048	50	6.2	
†1N2973B	9.1	275	2.0	250	960	.051	25	6.9	
†1N2974B	10	250	3	250	860	.055	25	7.6	
†1N2975B	11	230	3	250	780	.060	10	8.4	
†1N2976B	12	210	3	250	720	.065	10	9.1	
†1N2977B	13	190	3	250	660	.065	10	9.9	
†1N2978B	14	180	3	250	600	.070	10	10.5	
†1N2979B	15	170	3	250	560	.070	10	11.4	
†1N2980B	16	155	4	250	530	.070	10	12.2	
†1N2981B	17	145	4	250	500	.075	10	13.0	
†1N2982B	18	140	4	250	460	.075	10	13.7	
†1N2983B	19	130	4	250	440	.075	10	14.0	
†1N2984B	20	125	4	250	420	.075	10	15.2	
†1N2985B	22	115	5	250	380	.080	10	16.7	
†1N2986B	24	105	5	250	350	.080	10	18.2	
†1N2987B	25	100	6	250	310	.080	10	18.2	
†1N2988B	27	95	7	250	300	.085	10	20.6	
†1N2989B	30	85	8	300	280	.085	10	22.8	
†1N2990B	33	75	9	300	260	.085	10	25.1	
†1N2991B	36	70	10	300	230	.085	10	27.4	
†1N2992B	39	65	11	300	210	.090	10	29.7	
†1N2993B	43	60	12	400	195	.090	10	32.7	
†1N2994B	45	55	13	400	185	.090	10	33.0	
†1N2995B	47	55	14	400	175	.090	10	35.8	
†1N2996B	50	50	15	500	165	.090	10	36.0	
†1N2997B	51	50	15	500	160	.090	10	38.8	
†1N2998B	52	50	15	500	160	.090	10	39.0	
†1N2999B	56	45	16	500	150	.090	10	42.6	
†1N3000B	62	40	17	600	130	.090	10	47.1	
†1N3001B	68	37	18	600	120	.090	10	51.7	
†1N3002B	75	33	22	600	110	.090	10	56.0	
†1N3003B	82	30	25	700	100	.090	10	62.2	
†1N3004B	91	28	35	800	85	.090	10	69.2	
†1N3005B	100	25	40	900	80	.090	10	76.0	
†1N3006B	105	25	45	1000	75	.095	10	76.0	
†1N3007B	110	23	55	1100	72	.095	10	83.6	
†1N3008B	120	20	75	1200	67	.095	10	91.2	
†1N3009B	130	19	100	1300	62	.095	10	98.8	
†1N3010B	140	18	125	1400	58	.095	10	100.0	
†1N3011B	150	17	175	1500	54	.095	10	114.0	
†1N3012B	160	16	200	1600	50	.095	10	121.6	
†1N3013B	175	14	250	1750	46	.095	10	135.0	
†1N3014B	180	14	260	1850	45	.095	10	136.8	
†1N3015B	200	12	300	2000	40	.100	10	152.0	

**SILICON
10 WATT
ZENER DIODES**

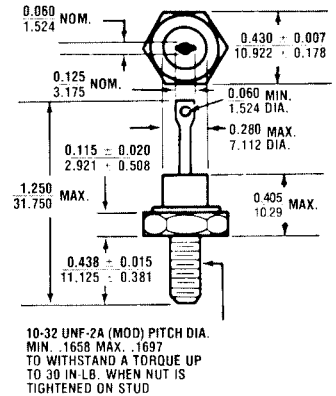

10-32 UNF-2A (MOD) PITCH DIA. MIN. .1658 MAX. .1697 TO WITHSTAND A TORQUE UP TO 30 IN-LB. WHEN NUT IS TIGHTENED ON STUD

FIGURE 1

All dimensions in INCH m.m.

MECHANICAL CHARACTERISTICS

CASE: Industry Standard DO-4, (DO-203AA), 7/16" Hex. stud with 10-32 threads, welded, hermetically sealed metal and glass.

FINISH: All external surfaces are corrosion resistant and terminal solderable.

WEIGHT: 7.5 grams.

MOUNTING POSITION: Any

THERMAL RESISTANCE: 10°C/W (Typical) junction to stud.

POLARITY:

IN3993 - IN4000: Std. Polarity is cathode to stud. Reverse polarity (anode to stud) indicated by suffix "R."

IN2970 - IN3015: Std. Polarity is anode to stud. Reverse polarity indicated by suffix "R."

MOUNTING HARDWARE:

See page 2-9.

*JEDEC Registered Data. **Not JEDEC Data.

† Have JAN and JANTX Qualifications to MIL-S-19500/272.

†† Have JAN, JANTX and JANTXV Qualifications to MIL-S-19500/124.

1N2970 thru 1N3015B, 1N3993 thru 1N4000A

NOTE 1 1N3993-1N4000 series: suffix A indicates $\pm 5\%$ tolerance, no suffix indicates $\pm 10\%$ tolerance. 1N2970-1N3015 series: suffix B indicates $\pm 5\%$ tolerance, suffix A indicates $\pm 10\%$, no suffix indicates $\pm 20\%$ tolerance. If tighter tolerance is required, consult factory.

NOTE 2 The electrical characteristics are measured after allowing the device to stabilize for 90 seconds with 30°C Base temperature.

NOTE 3 The zener impedance (Z_{ZT}) is derived from the 60 Hz ac voltage, which results when an ac current having an rms value equal to 10% of the DC zener current (I_{ZT} or I_{ZK}) is

superimposed on I_{ZT} or I_{ZK} . When making zener impedance measurements at the I_{ZK} test point, it may be necessary to insert a 60 Hz band pass filter between the diode and voltmeter to avoid errors resulting from low level noise signals. A curve showing the variation of zener impedance vs. zener current for three representative types is shown in Figures 3 and 4.

NOTE 4 These values of I_{ZTM} may be exceeded in the case of individual diodes. The values shown are calculated for the worst case which is a unit of $\pm 5\%$ tolerance at the high voltage end of its tolerance range. Allowance has also been made for the rise in zener voltage above V_{ZT} , which results from zener impedance and the increase in junction temperature as power dissipation approaches 10 watts.

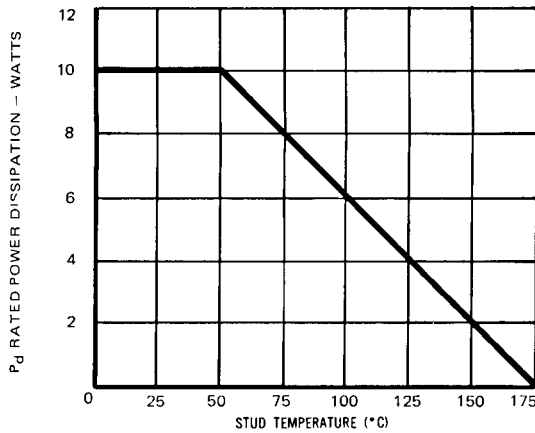

FIGURE 2
POWER DERATING CURVE

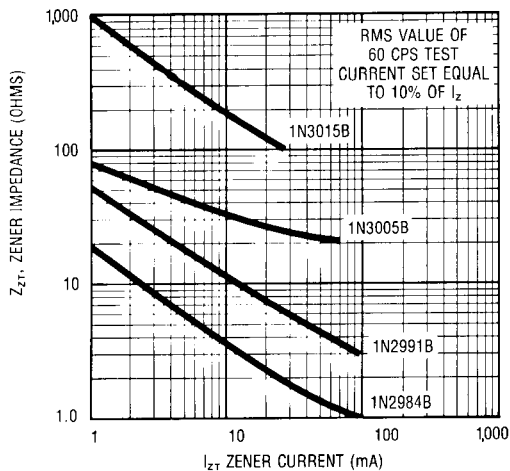

FIGURE 3

TYPICAL ZENER IMPEDANCE vs. ZENER CURRENT
FOR TYPES SHOWN

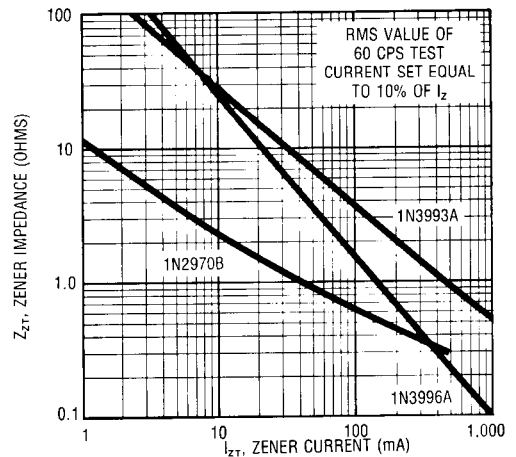

FIGURE 4

TYPICAL ZENER IMPEDANCE vs. ZENER CURRENT
FOR TYPES SHOWN